



amics

Advanced Motor Solutions for Industry



Motor Solutions for **Automation**



Motor Solutions for **Manufacturing**



Motor Solutions for **Healthcare**



Motor Solutions for Intralogistics



Motor Solutions for **Agriculture**



Motor Solutions for **Agro-Tech**

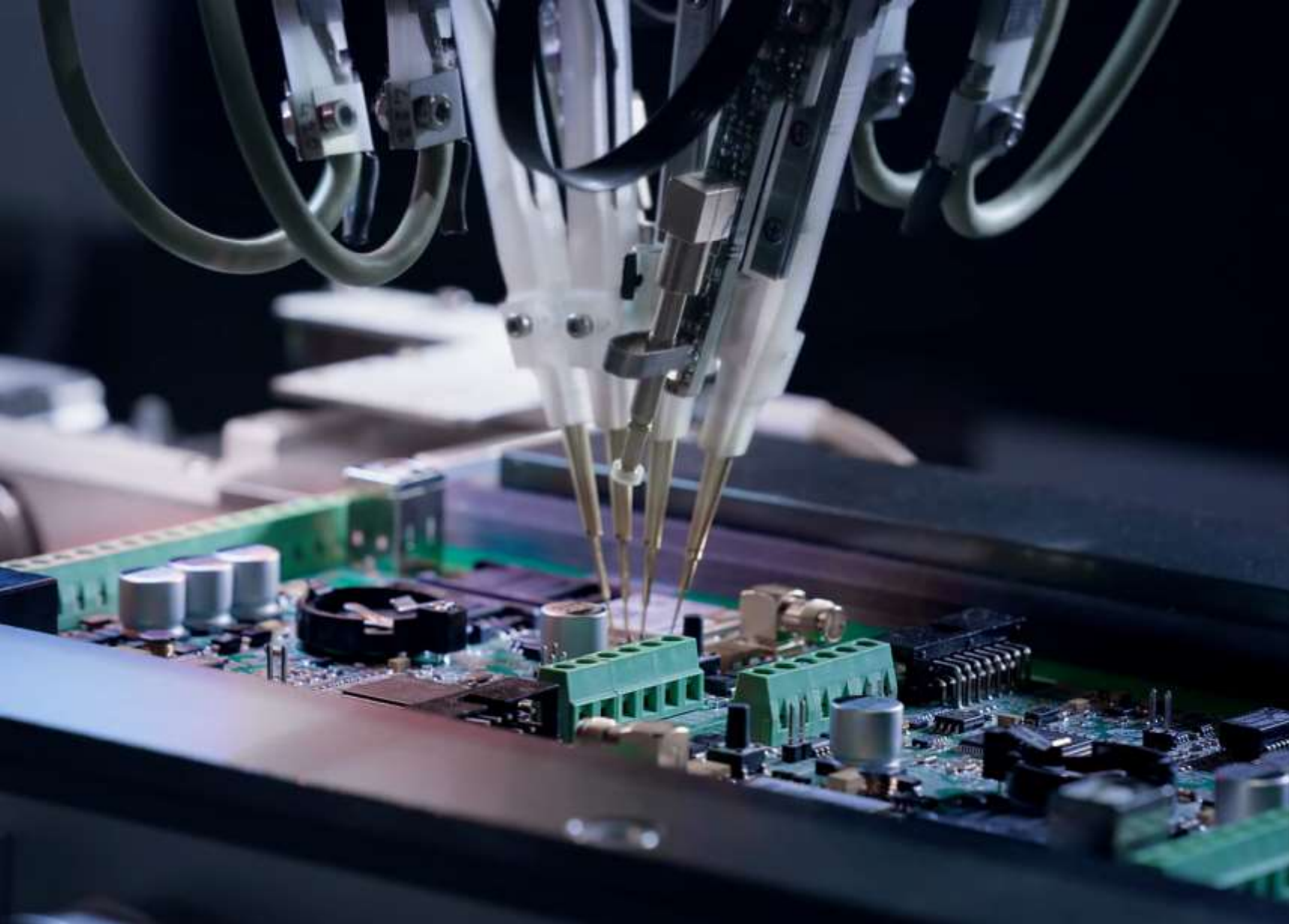

Motor Solutions for **Test & Measurement**



Motor Solutions for **Defence**



Motor Solutions for **Aerospace**

PMW Dynamics



Motor Solutions for **Every** Industry

PMW Dynamics

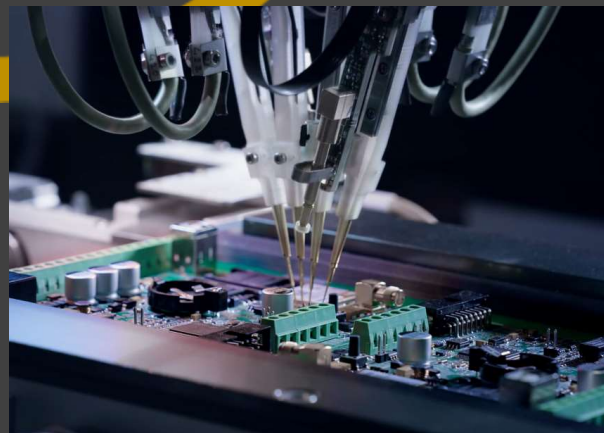

Motor Solutions for **YOU**



amics

Your Motor Development **Partner**

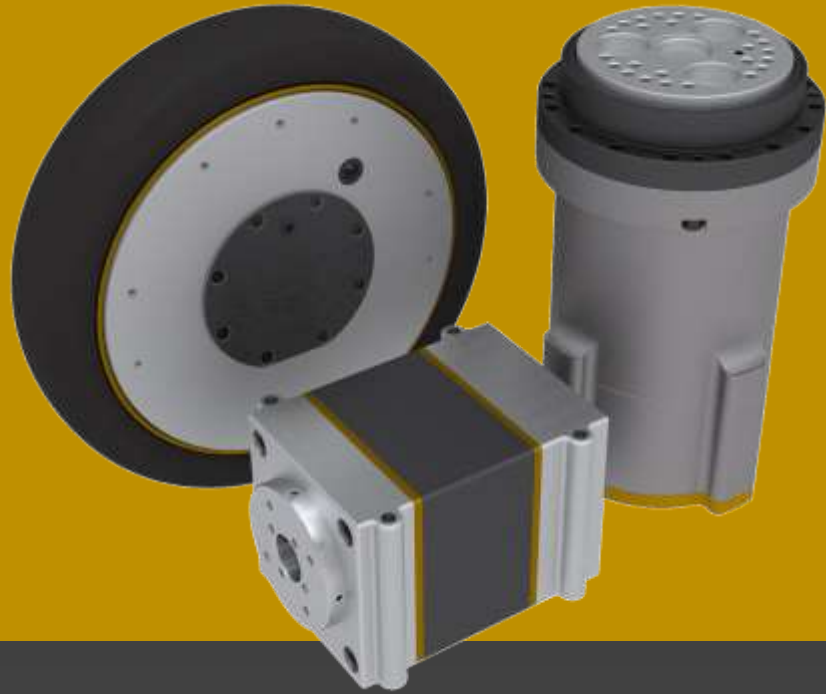

Advanced Servo Motors for Industry ...

Three Possibilities ...

- Comprehensive Motor Portfolio
- Customise Existing Design
- Full Bespoke Development



Aerospace



Agricultural



Automotive



Defence



Industrial



Marine



Medical



Oil & Gas



Robotics



Test & Measurement

- Brushed | Brushless
- Axial | Radial Flux Designs
- Inner | Outer Rotor Configurations
- Pancake | Cylindrical Form Factor
- Housed | Frameless | Kit
- Geared | Direct Drive
- Sensorless | Halls | Encoder | Resolver Feedback



PMW Dynamics Portfolio

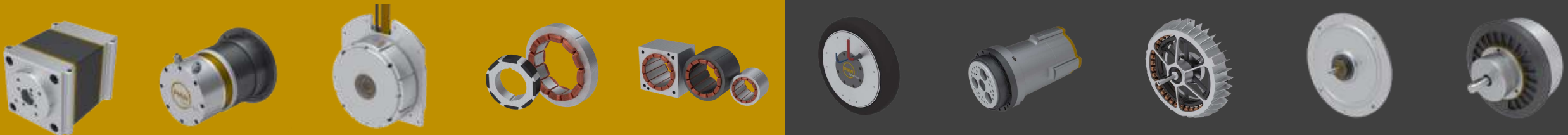

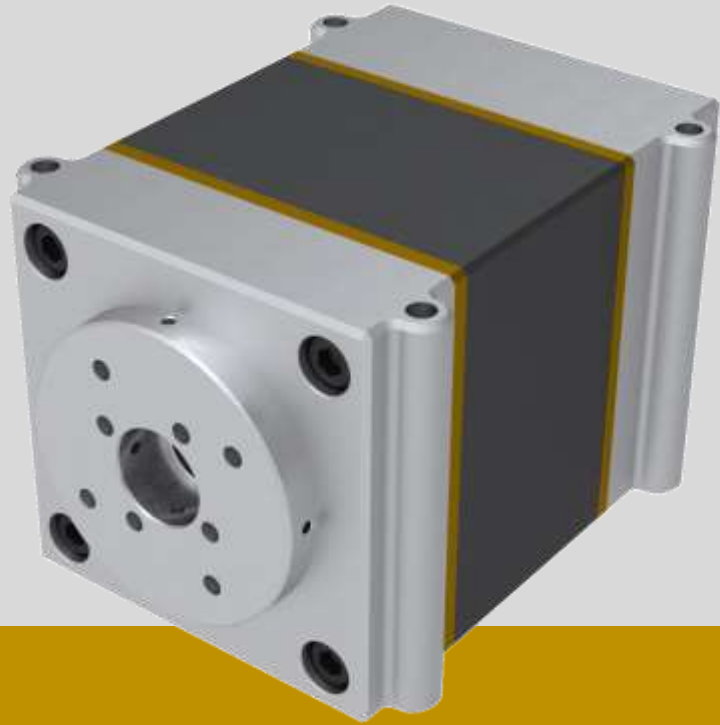

Brushed & Brushless Motor Designs

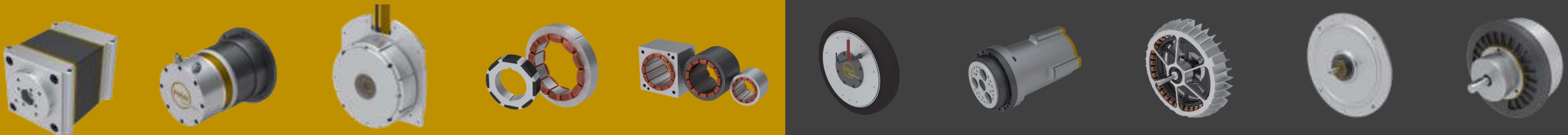



Geared Motor with Integrated Drive





Inner & Outer Rotor Motor Configurations

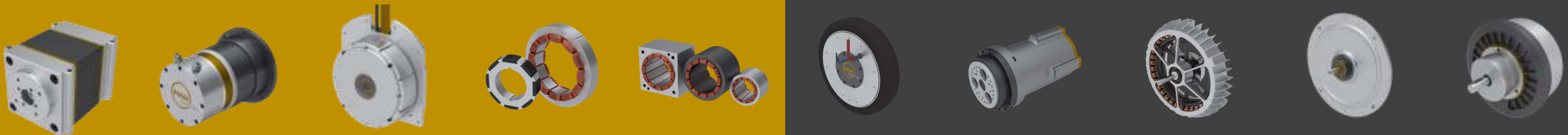

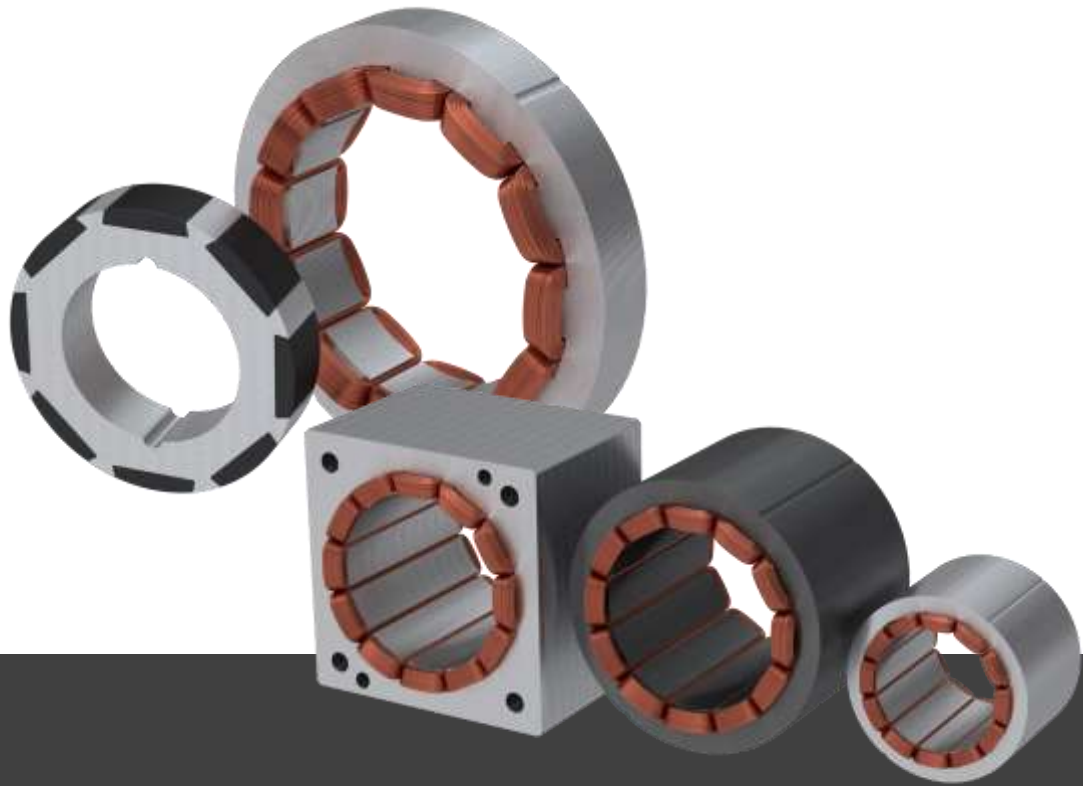

Pancake & Cylindrical Motor Form Factors





Housed, Frameless & Kit Motor Packages

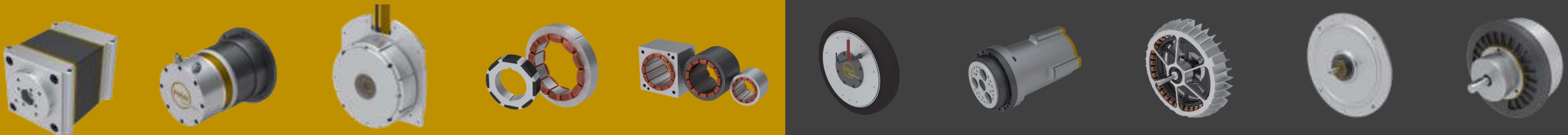



Geared & Direct-Drive Motor Solutions





In-Wheel & Hub Motor Specialists

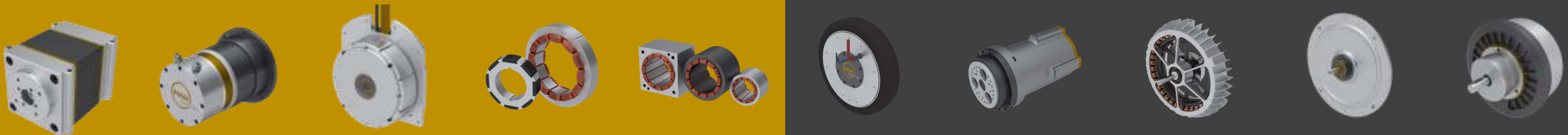



Flat Armature ServoDisc Motors



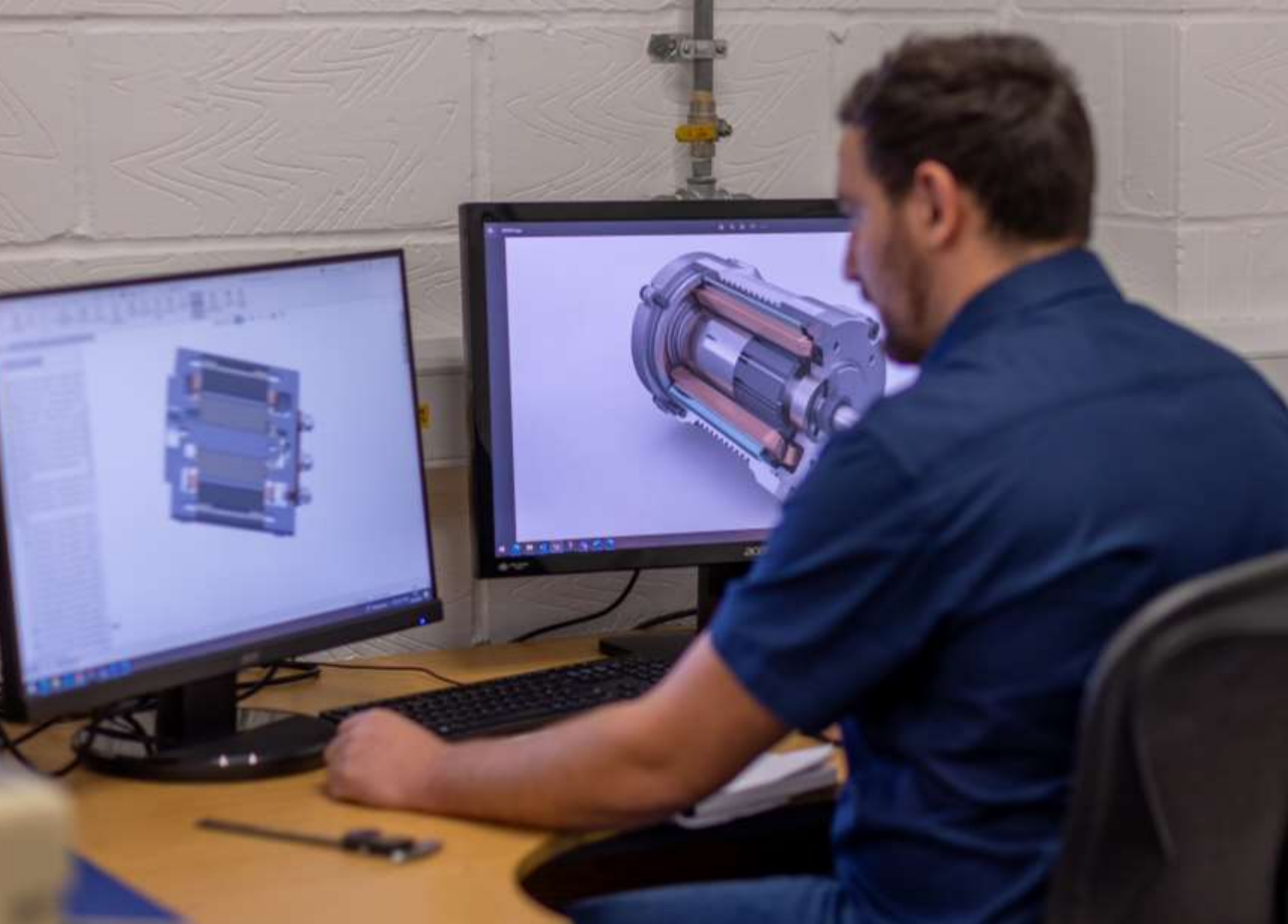

Every Motor Concept **100%** Modelled



Every Motor Design **100%** Proven



Every Motor Assembly **100%** Inspected



Every Motor Product **100%** Tested